

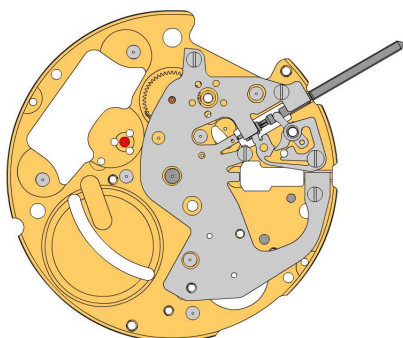

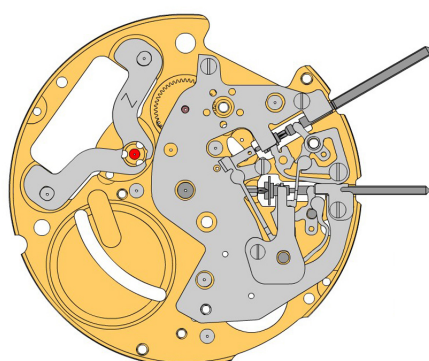

















A

B

C

2000.627.G 1.		Platine
3017.052 2.		Tirette dual
3015.075 3.		Bascule dual Bascule dual tenue par 1 vis 4000.282.
4000.282 4.		Vis
3001.044 5.		Pignon coulant
3000.190.CO 6.		Tige de mise à l'heure dual
3315.018 7.		Clinquant
3301.277 8.		Roue des heures dual (Aig.1)

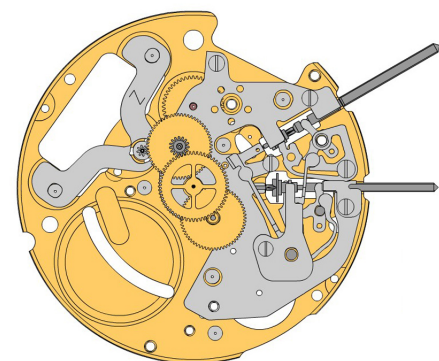
2130.167.CO 9.		Couvre-mécanisme Couvre-mécanisme tenue par 3 vis 4000.321. Les pièces 2130.167.CO et 3004.188 doivent être échangées ensemble.
4000.312 10.		Vis

3017.057 11.		Tirette
3015.074 12.		Bascule (3 positions) Mise en tension du ressort.
3001.042.FI 13.		Pignon coulant
3000.189.CO 14.		Tige de mise à l'heure
2020.166 15.		Pont de bascule Pont de bascule tenue par 1 vis 4000.328.
4000.328 16.		Vis
2130.199 17.		Plaquette de tige Plaquette de tige tenue par 1 vis 4000.312.
4000.312 18.		Vis
3622.042 19.		Stator Marquage [Z] sur le stator.





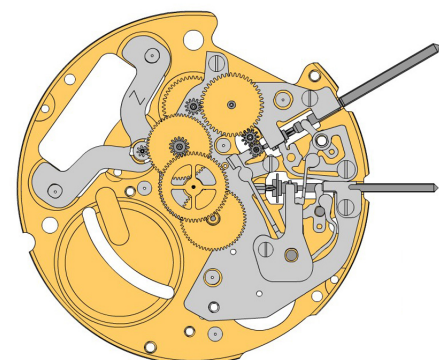

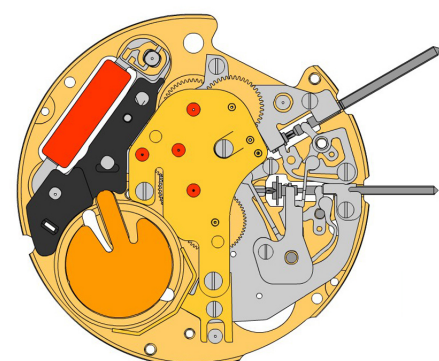

D

3715.103.RK 20.		Rotor
3147.056.CO 21.		Roue intermédiaire
3122.059.CO 22.		Roue moyenne
3136.162.CO 23.		Roue de seconde au centre (Aig.1)





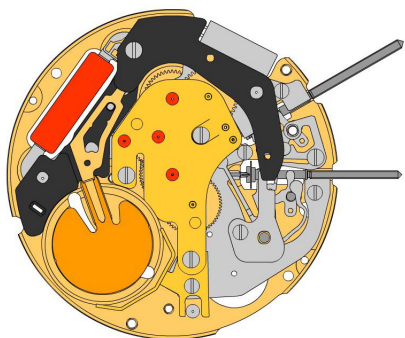
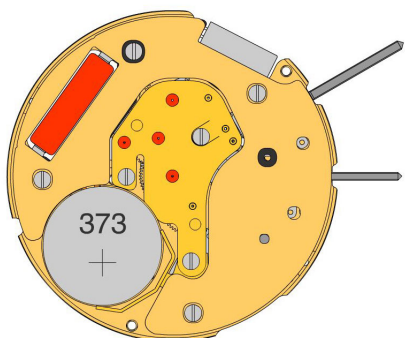

E

3305.313.FI 24.		Pignon chausée dual (Aig.1)
3004.185.CO 25.		Renvoi intermédiaire dual
3004.198.FI 26.		Renvoi dual
3007.074.CO 27.		Roue de minuterie dual









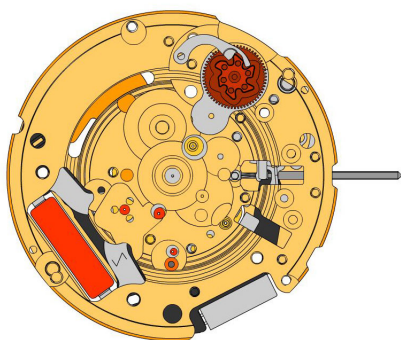
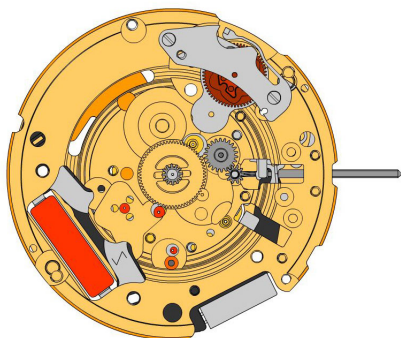
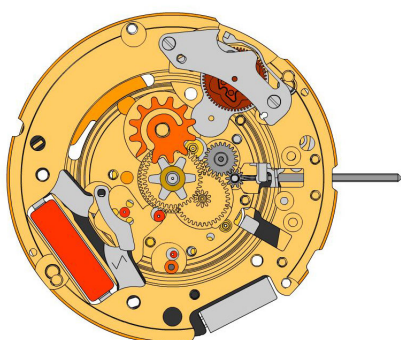



F

2020.180.G 28.		Pont de rouage Pont de rouage gehalten durch 3 Schrauben 4000.279.
4000.279 29.		Vis
3601.117.G 30.		Bride pile (+) Bride latérale tenue par 1 vis 4000.244.
4000.244 31.		Vis
3621.060.RK 32.		Bobine Attention: Prendre la bobine uniquement par le noyau de bobine gris.
3603.074 33.		Isolateur bride (-)
3603.075 34.		Isolateur pile

G

H

3601.116 35.		Bride - Placer la bride (-) selon image.
3612.181 36.		Module électronique Module électronique tenue par 1 vis 4000.318. Les mesures électroniques peuvent être réaliser maintenant.
4000.318 37.		Vis
2130.168.G.M01.6203B 38.		Couvre-module électronique Couvre-module électronique tenue par 3 vis 4000.102.
4000.102 39.		Vis
3600.031.HGF 40.		Pile 373

I

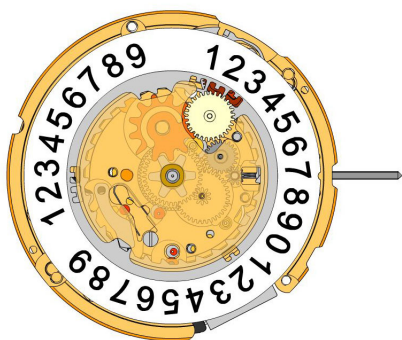
J

K

2000.627.G 41.		Platine
3004.188 42.		Roue entraîneuse des dizaines Positionnement de la dent courte de la roue entraîneuse des dizaines en direction le centre du mouvement. Les pièces 2130.167.CO et 3004.188 doivent être échangées ensemble.
3500.060 43.		Sautoir des dizaines
2130.171 44.		Plaque de maintien du sautoir des dizaines Plaque de maintien du sautoir des dizaines tenue par 2 vis 4000.332. Mise en tension du ressort.
3004.182.FI 45.		Renvoi
3004.183.FI 46.		Renvoi intermédiaire
3305.308.CO 47.		Chaussée ave entraîneur (Aig.1)
3007.081.CO 48.		Roue de minuterie
3301.273.CO 49.		Roue des heures (Aig.1)
3315.001 50.		Clinquant
3004.187 51.		Roue entraîneuse de quantième
3500.061 52.		Sautoir de quantième

L
3504.217.AF.1.A
53.

Indicateur des unités (standard)
 Marquage de l'indicateur à 3 heures.

3147.057
54.

Roue intermédiaire dizaines
2130.169
55.

Plaque maintien indicateur de quantième
 Plaque maintien indicateur de quantième tenue par 1 vis 4000.312.

4000.312
56.

Vis
3905.070
57.

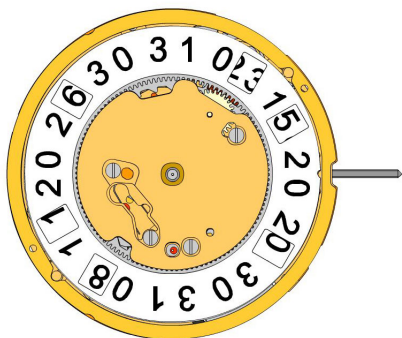
Ressort du sautoir de quantième
 Insertion du ressort sautoir de quantième dans l'ouverture.

M
3504.218.AF.1.A
58.

Indicateur des dizaines (standard)
 Marquage de l'indicateur à 3 heures.

2130.170.G
59.

Plaque de maintien du mécanisme de quantième
 Plaque de maintien du mécanisme de quantième tenue par 3 vis 4000.312.

4000.312
60.

Vis
3506.075.G
61.

Support de cadran
8200
62.

Moebius 8200
9014
63.

Moebius 9014
124
64.

Jismaa 124
9020
65.

Moebius 9020

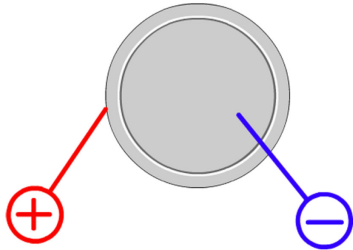

Pile	373
Tension	1.55 V

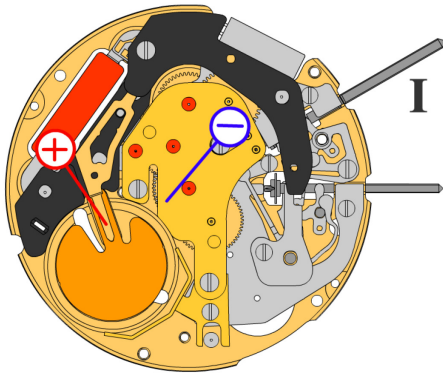

Tige de mise à l'heure en position I, calendrier hors engrenage, intervalle de mesure 60 s pour la marche et la consommation:

Consommation typique	0.96 μA
Consommation maximale	1.85 μA
Marche	-10s/M. .. +20s/M.
Limite inférieure de la tension de fonctionnement	1.20 V

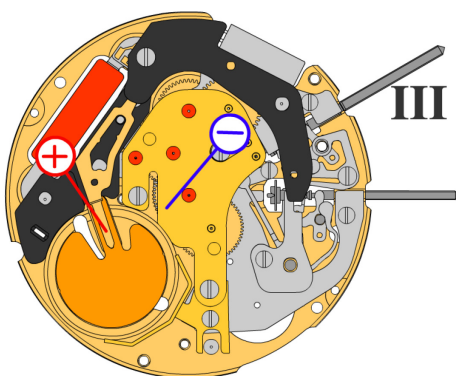

Tige de mise à l'heure en position III, intervalle de mesure 60 s:

Typical consumption	0.10 μA
Maximal consumption	0.30 μA

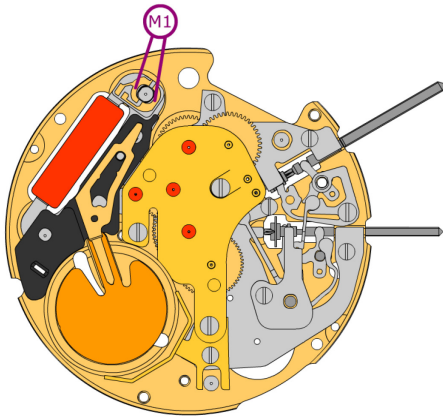

Résistance de la bobine M1

1.61 k Ω .. 1.81 k Ω

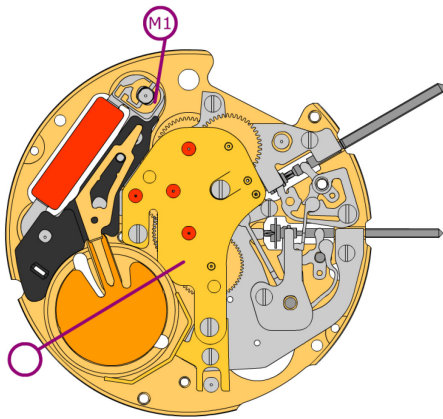

Isolation de la bobine M1

∞ k Ω