

Vis No.:
Schraube Nr.: 4000.236
Screw No.:

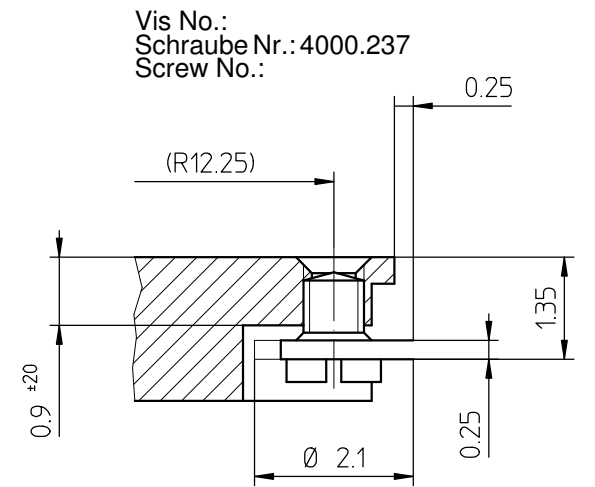

Vis No.:
Schraube Nr.: 4000.237
Screw No.:

Sécurité entre aiguille minute et verre
Sicherheit zwischen Minutenzeiger und Glas
Security between minute hand and glass

: min 0.30 mm
: min 0.30 mm
: min 0.30 mm

Cage
Uhrwerkgestell 11½"
Frame

RONDA 1016

Pile
Batterie
Battery Ø7.90 x 1.65

Issued	20 Mai 2008	dh
Modified	22 Mai 2013 ÄÄ 13271	dh
Released	YES	
Tolerance	+/- 20 µm	
Scale	10 : 1 (5 : 1) (A3H)	

Sous réserve de modifications
Änderungsvorbehalten
Modifications reserved

No. 5000.378 02