

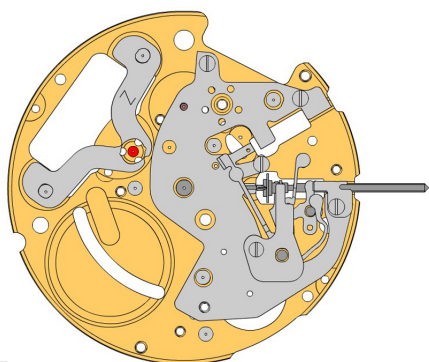

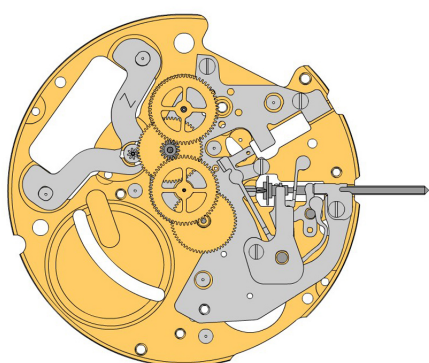

A















B



C

2000.628.G 1.		Werkplatte
2130.204.CO 2.		Deckplatte für Stelleinrichtung Deckplatte für Stelleinrichtung gehalten durch 3 Schrauben 4000.321.
4000.321 3.		Schraube

3017.057 4.		Winkelhebel
3015.074 5.		Wippe (3 Positionen) Den Federarm spannen.
3001.042.FI 6.		Kupplungstrieb
3000.189.CO 7.		Stellwelle
2020.166 8.		Wippenbrücke Wippenbrücke gehalten durch 1 Schraube 4000.328.
4000.328 9.		Schraube
2130.199 10.		Halteplatte für Stellwelle Halteplatte für Stellwelle gehalten durch 1 Schraube 4000.312.
4000.312 11.		Schraube
3622.042 12.		Stator Markierung [Z] auf Stator.

3715.103.RK 13.		Rotor
3147.056.CO 14.		Zwischenrad
3122.059.CO 15.		Kleinbodenrad
3136.163.CO 16.		Zentrumsekundenrad kurz
3136.167.CO 17.		Kleines Sekundenrad (Aig.1)

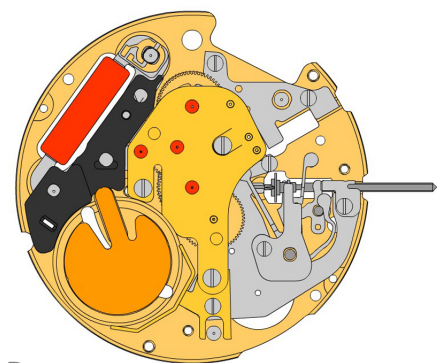



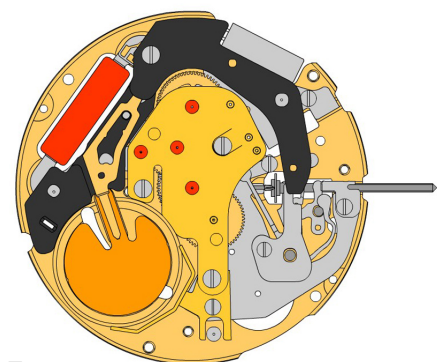



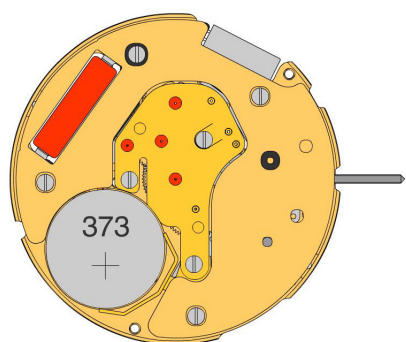





D



E



F

2020.180.G 18.		Räderwerkbrücke Räderwerkbrücke gehalten durch 3 Schrauben 4000.279.
4000.279 19.		Schraube
3601.117.G 20.		Batteriehalter (+) Seitlicher Bügel gehalten durch 1 Schraube 4000.244.
4000.244 21.		Schraube
3621.060.RK 22.		Spule Achtung: Spule nur am grauen Spulenkern halten.
3603.074 23.		Isolation für (-) Bügel
3603.075 24.		Isolation für Batterie
3601.116 25.		Bügel - Bügel wie abgebildet ausrichten.
3612.181 26.		Elektronikmodul Elektronikmodul gehalten durch 1 Schraube 4000.318. Elektronische Messungen können nun vorgenommen werden.
4000.318 27.		Schraube
2130.168.G.M01.6004B 28.		Deckplatte für Elektronikmodul Deckplatte für Elektronikmodul gehalten durch 3 Schrauben 4000.102.
4000.102 29.		Schraube
3600.031.HGF 30.		Batterie 373

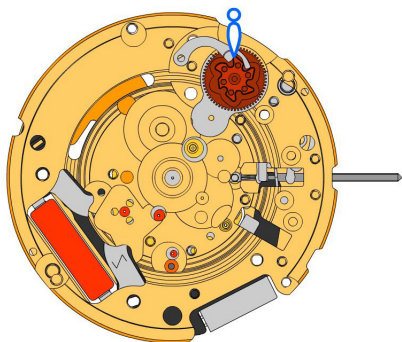

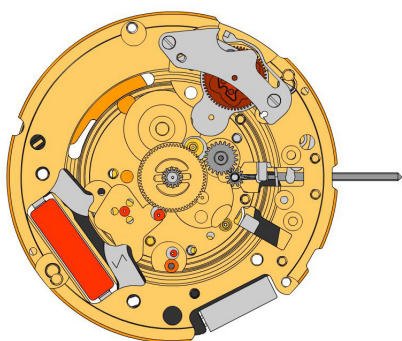

G



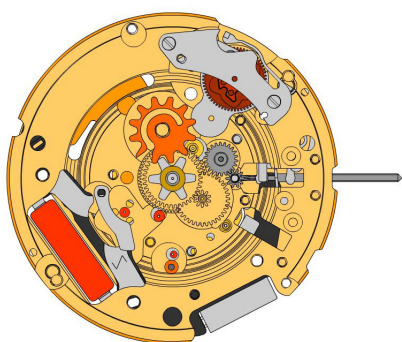









H



I



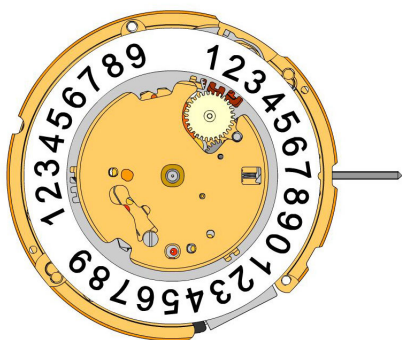

2000.628.G 31.		Werkplatte
3004.232 32.		Zehnermitnehmerrad Kurzen Zahn des Zehnermitnehmerrades in Richtung Werkszentrum positionieren.
3500.060 33.		Zehnerraste

2130.171 34.		Halteplatte für Zehnerraste Halteplatte für Zehnerraste gehalten durch 2 Schrauben 4000.332. Den Federarm spannen.
4000.332 35.		Schraube
3004.182.FI 36.		Zeigerstellrad Mit Moebius 9020 ölen.
3004.183.FI 37.		Zwischen-Zeigerstellrad
3305.307.CO 38.		Minutenrohr mit Mitnehmer (Aig.1, geschlossen)

3007.073.CO 39.		Wechselrad
3301.272.CO 40.		Stundenrad (Aig.1)
3315.001 41.		Frikionsfeder
3004.187 42.		Datumanzeiger-Mitnehmerrad
3500.061 43.		Datumraste





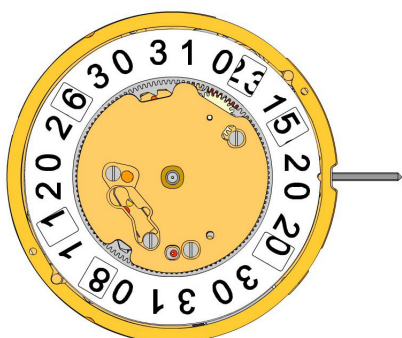

J

3504.217.AF.1.A 44.		Einer Anzeiger (Standard) Einbuchtung im Disc bei 3 Uhr.
3147.057 45.		Zehnerzwischenrad
2130.169 46.		Halteplatte für Datumanzeige Halteplatte für Datumanzeige gehalten durch 1 Schraube 4000.312.
4000.312 47.		Schraube
3905.070 48.		Feder für Datumraste Feder für Datumraste in die Öffnung einfügen.



K

3504.218.AF.1.A 49.		Zehner Anzeiger (Standard) Einbuchtung im Disc bei 3 Uhr.
2130.170.G 50.		Halteplatte für Datum-Mechanismus Halteplatte für Datum-Mechanismus gehalten durch 3 Schrauben 4000.312.
4000.312 51.		Schraube
3506.075.G 52.		Träger für Zifferblatt

8200 53.		Moebius 8200
9014 54.		Moebius 9014
124 55.		Jismaa 124
9020 56.		Moebius 9020

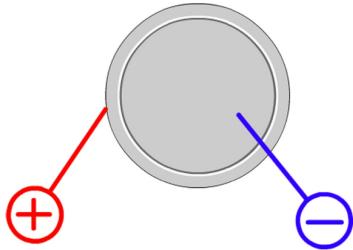

Batterie	373
Spannung	1.55 V

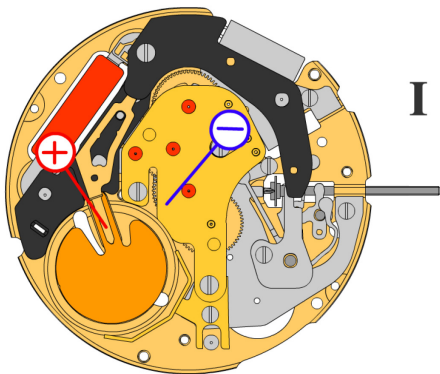
I

*Stellwelle in Position I, Kalender nicht im Eingriff,
60 s Messintervall für Gang und Verbrauch:*

Typischer Verbrauch	1.03 μA
Maximaler Verbrauch	1.85 μA
Gang	-10s/M. .. +20s/M.
Untere Funktionsspannungsgrenze	1.20 V

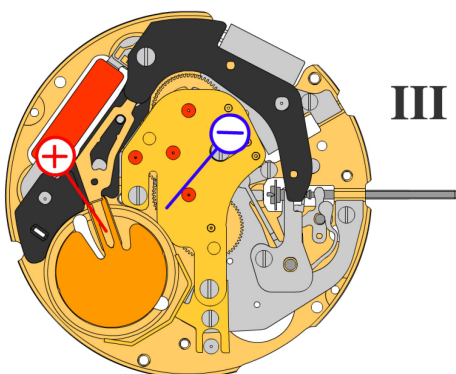
III

Stellwelle in Position III, 60 s Messintervall:

Typischer Verbrauch	0.10 μA
Maximaler Verbrauch	0.30 μA

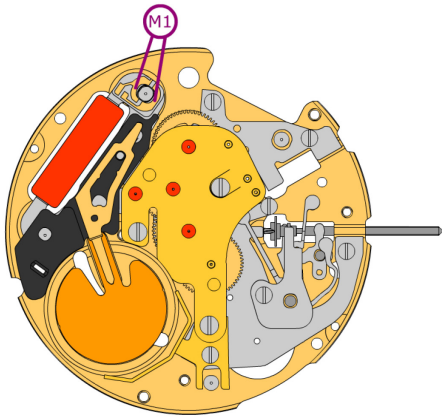

Spulenwiderstand M1

1.61 k Ω .. 1.81 k Ω

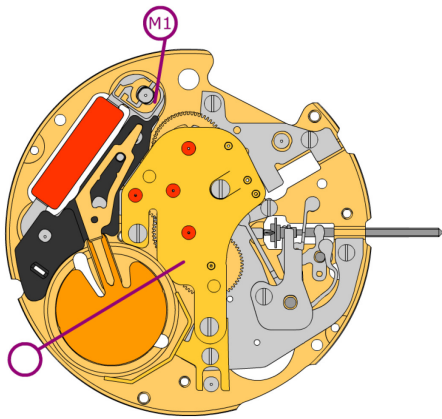

Spulenisolation M1

∞ k Ω