

8 3/4'''



782



783



784

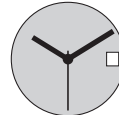

785

**Funktionen**

**Fonctions**

**Functions**

Kaliber Calibre Caliber	Stellwellenpos. Pos. de tige Stem position	Funktionen Fonctions Functions
<b>782/783</b>	1	Normale Position / Position normale / Running position Zeiger stellen, Sekunden-Stopp mit Unterbruch der Motorimpulse
	2	Mise à l'heure, stop-seconde avec interruption des impulsions moteur Hand setting, stop-second with interruption of motor impulses
<b>784/785</b>	1	Normale Position / Position normale / Running position
	2	Datumkorrektur / Correction de la date / Date correction
	3	Zeiger stellen, Sekunden-Stopp mit Unterbruch der Motorimpulse Mise à l'heure, stop-seconde avec interruption des impulsions moteur Hand setting, stop-second with interruption of motor impulses

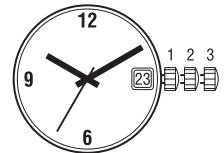
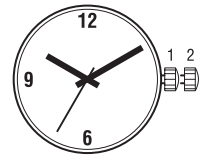

**Batterie**

**Pile**

**Battery**

Kaliber Calibre Caliber	Batterie Pile Battery	Spannung Voltage Tension	Artikelnummer RONDA Numero d'article RONDA Part number RONDA
782-785	362 / SR721SW	1.55 V	3600.014.HGF

8 3/4''' 782, 783, 784, 785

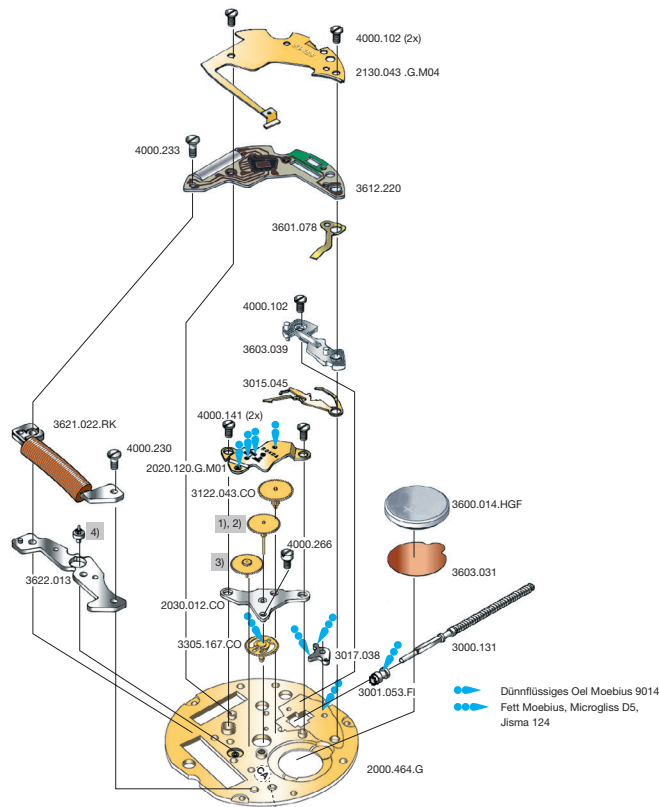

Cal. 783 Werkseite / Côté mouvement / Movement side			
Nr. / No. / No.	Bestandteile	Fournitures	Spare Parts
2000.464.G	Werkplatte	Platine	Main Plate
2020.120.G.M01	Räderwerkbrücke	Pont rouge	Train w. bridge
2030.012.CO	Zentrumbrücke	Pont centre	Centre bridge
2130.043.G.M04	Modul-Abdeckp.	Couvre module	Module cover pl.
3000.131	Stellwelle	Tige	Stem
3001.053.FI	Kupplungstrieb	Pignon coulant	Sliding pinion
3015.045	Kuppl.-triebhebel	Bascule	Yoke
3017.038	Winkelhebel	Tirette	Setting lever
3122.043.CO	Kleinbodenrad	Roue moyenne	Third wheel
1)	Sekundenrad	Roue secondes	Second-wheel
3)	Zwischenrad	Roue interméd.	Intermed. wheel
3305.167.CO	Minutenrohr	Chaussée	Cannon pinion
3600.014.HGF	Batterie	Pile	Battery
3601.078	Batterie-Kontakt	Bride contact	Battery contact
3603.031	Batterie-Isolation	Isolateur pile	Battery insulation
3603.039	Deckplatte/ Ste.	Couvre mécan.	Setting lev. cover
3612.220	Modul	Module	Module
3621.022.RK	Spule	Bobine	Coil
3622.013	Stator	Stator	Stator
4)	Rotor	Rotor	Rotor
4000.102	Schraube	Vis	Screw
4000.141	Schraube	Vis	Screw
4000.230	Schraube	Vis	Screw
4000.233	Schraube	Vis	Screw
4000.266	Schraube	Vis	Screw

Code: Beispiel CA / exemple CA / exemple CA

Cal. 783, 785		
Bis Dez. 2013	Jusqu' en Dec. 2013	Ab Jan. 2014
Untill Dec. 2013		A partir de Jan. 2014
		From Jan. 2014

Code	2. Buchstabe ... Z Second letter ... Z 2 <sup>ème</sup> chiffre: ... Z	2. Buchstabe: ab A Second letter: from A 2 <sup>ème</sup> chiffre: à partir de A
1)	3136.087.CO	3136.212.CO
3)	3147.019.CO	3147.092.CO
4)	3715.030.RK	3715.139.RK

Die obigen 3 Teile bilden jeweils eine Gruppe. Deshalb sind die 3 Teile jeder Gruppe nicht einzeln gegeneinander austauschbar.

Les 3 fournitures ci-dessous forment un groupe individuel. C'est pourquoi les 3 fournitures de chaque groupe ne sont pas interchangeables.

The 3 parts mentioned above are forming an individual group. Therefore the 3 parts of each group are not interchangeable.

Abweichungen / Divergences / Deviations

Cal. 785 Werkseite / Côté mouvement / Movement side			
3015.040	Kuppl.-triebhebel	Bascule	Yoke

Cal. 782 Werkseite / Côté mouvement / Movement side			
2)	Sekundenrad	Roue secondes	Second-wheel
3)	Zwischenrad	Roue interméd.	Intermed. wheel
3305.176.CO	Minutenrohr	Chaussée	Cannon pinion
4)	Rotor	Rotor	Rotor

Cal. 784 Werkseite / Côté mouvement / Movement side			
3015.040	Kuppl.-triebhebel	Bascule	Yoke
2)	Sekundenrad	Roue secondes	Second-wheel
3)	Zwischenrad	Roue interméd.	Intermed. wheel
3305.176.CO	Minutenrohr	Chaussée	Cannon pinion
4)	Rotor	Rotor	Rotor

Cal. 782, 784		
Bis Dez. 2013	Jusqu' en Dec. 2013	Ab Jan. 2014
Untill Dec. 2013		A partir de Jan. 2014
		From Jan. 2014

Code	2. Buchstabe ... Z Second letter ... Z 2 <sup>ème</sup> chiffre: ... Z	2. Buchstabe: ab A Second letter: from A 2 <sup>ème</sup> chiffre: à partir de A
2)	3136.093.CO	3136.196.CO
3)	3147.019.CO	3147.092.CO
4)	3715.030.RK	3715.139.RK

Die obigen 3 Teile bilden jeweils eine Gruppe. Deshalb sind die 3 Teile jeder Gruppe nicht einzeln gegeneinander austauschbar.

Les 3 fournitures ci-dessous forment un groupe individuel. C'est pourquoi les 3 fournitures de chaque groupe ne sont pas interchangeables.

The 3 parts mentioned above are forming an individual group. Therefore the 3 parts of each group are not interchangeable.

# Werkaufbau



# Assemblage

# Assembling

8 3/4''' 784, 785

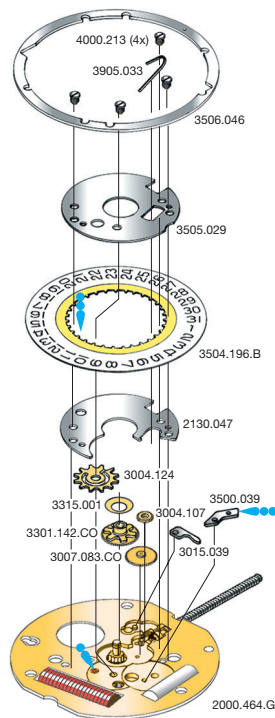
8 3/4''' 782, 783



 Düninflüssiges Öl Moebius 9014  
 Fett Moebius, Microgliss D5, Jisma 124

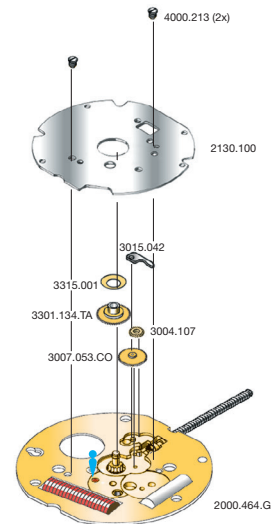

 Düninflüssiges Öl Moebius 9014

Cal. 784, 785 Zifferblattseite / Côté cadran / Dial side			
Nr./No./No.	Bestandteile	Fournitures	Spare Parts
3004.107	Zeigerstellrad	Renvoi minuterie	Setting wheel
3004.124	Datummitn.-Rad	Renvoi entrain.	Ind. driving wheel
3007.083.CO	Wechselrad	Minuterie	Minute wheel
3015.039	Kup.triebbebel u.	Bascule dessous	Lower sec. yoke
3301.142.CO	Stundenrad	Canon	Hour wheel
3315.001	Spreizfeder	Clinquant 2 1/2	Washer 2 1/2
3500.039	Datumraste	Cliquet calend.	Date jumper
3504.196.B	Datumanzeiger	Bague	Date indicator
3505.029	Kal.-Abdeckplatte	Couvercle calend.	Date ind. guard
3506.046	Zifferblattstützring	Support cadran	Dial support
3905.033	Feder Datumraste	Ressort calend.	Date jumper spr.
4000.213	Schraube	Vis	Screw

Cal. 782, 783 Zifferblattseite / Côté cadran / Dial side			
Nr./No./No.	Bestandteile	Fournitures	Spare Parts
2130.100	Zeigerwerkhaltep.	Plaque calend.	Date ind. plate
3004.107	Zeigerstellrad	Renvoi minuterie	Setting wheel
3007.053.CO	Wechselrad	Minuterie	Minute wheel
3015.042	Kup.triebbebel u.	Bascule dessous	Lower sec. yoke
3301.134.TA	Stundenrad	Canon	Hour wheel
3315.001	Spreizfeder	Clinquant 2 1/2	Washer 2 1/2
4000.213	Schraube	Vis	Screw

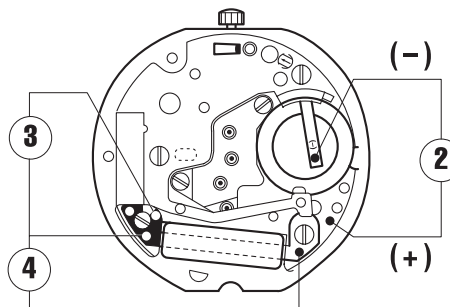
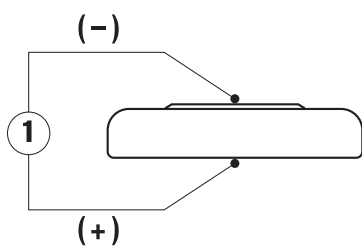

Kaliber Calibre Caliber	Pos. Pos. Pos.	Einheit Unité Unit	Messwerte Valeurs mesurées Measured values	Kontrolle Contrôle Check	Bemerkungen Remarques Remarks
782-785	1	V	1,55	Batterie-Spannung Tension de la pile Battery voltage	Batterie herausnehmen und messen Enlever et mesurer la pile Remove battery for measuring
782-785	2	µA	0,70-1,35	Stromaufnahme (Kalender nicht im Eingriff) Consommation de courant (quantième non en prise) Current consumption (Date mechanism not in gear)	Ohne Batterie, mit externer Speisung Sans pile, avec alimentation externe Without battery, with external power supply
782-785	2	V	≤ 1,35	Funktionskontrolle bei Minimalspannung Contrôle de fonctionnement à tension minimale Check with lowest possible voltage	Ohne Batterie, mit externer Speisung Sans pile, avec alimentation externe Without battery, with external power supply
782-785	3	KΩ	1,75-1,95	Spulenwiderstand Résistance de la bobine Resistance of the coil	Ohne Batterie Sans pile Without battery
782-785	4	KΩ	∞	Spulenisolation Isolation de la bobine Coil insulation	Ohne Batterie Sans pile Without battery
782-785		Sek./Monat sec./mois sec./month	- 10/+ 20	Induktivsonde 60 Sek. Senseur inductif 60 sec. Inductive sensor 60 sec.	Mit Batterie Avec pile With battery

Einschalen / Werkzeuge

Emboîtage / outils

Casing / tools

Nr. H 78X.1A



Nr. H 78X.1T



SWISS MADE	SWISS PARTS

Zeigersetzen

Maximale Aufpresskraft:

- Stunden und Minutenzeiger: max. 40N
- Sekundenzeiger: max. 30N

Beim Zeigersetzen muss das Werk abgestützt werden.

Poser les aiguilles

Force de chassage maximale:

- Aiguilles des heure et des minutes: max. 40N
- Aiguille des secondes: max. 30N

Lors de la pose d'aiguilles, le mouvement doit être soutenu.

Hand setting

Maximal force:

- Hour and minute hands: max. 40N
- Second hand: max. 30N

The movement needs to be supported for hand setting.

<b>Kal. 712, 713 Stellwelle entfernen</b>	<b>Kal. 714, 715 Stellwelle entfernen</b>
Beim Entfernen der Stellwelle muss sich die Stellwelle in <b>Position 1</b> (gedrückt) befinden, bevor auf den Winkelhebel gedrückt wird.	Beim Entfernen der Stellwelle muss sich die Stellwelle in <b>Position 2</b> befinden, bevor auf den Winkelhebel gedrückt wird.
<b>Kal. 712, 713 Enlever la tige</b>	<b>Kal. 714, 715 Enlever la tige</b>
En enlevant la tige, la tige doit se trouver en <b>position 1</b> (poussée), avant de pousser sur la tirette.	En enlevant la tige, la tige doit se trouver en <b>position 2</b> , avant de pousser sur la tirette.
<b>Kal. 712, 713 Stem removal</b>	<b>Kal. 714, 715 Stem removal</b>
For removal of the stem, the stem must be in <b>position 1</b> (pressed in) prior to apply pressure to the setting lever.	For removal of the stem, the stem must be in <b>position 2</b> prior to apply pressure to the setting lever.