

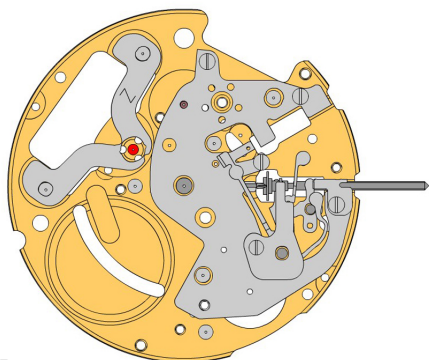

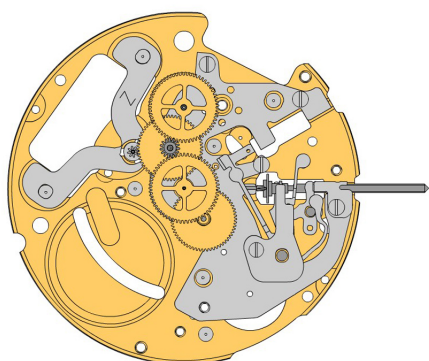

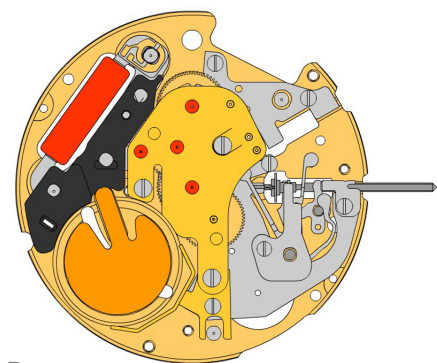

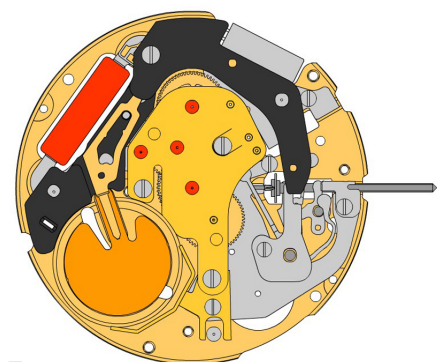

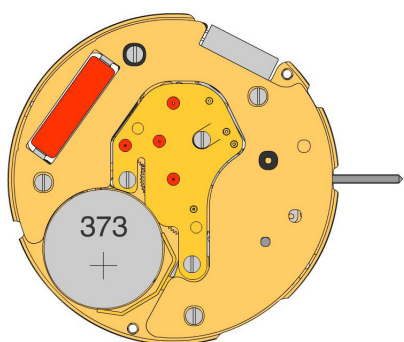







A

B

C

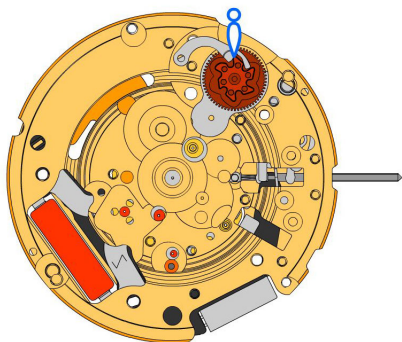
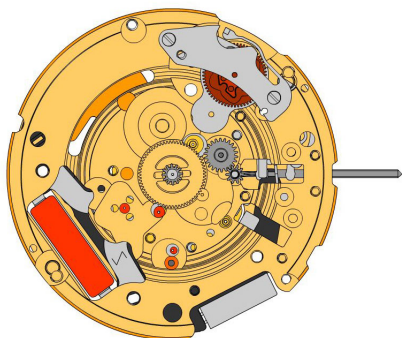
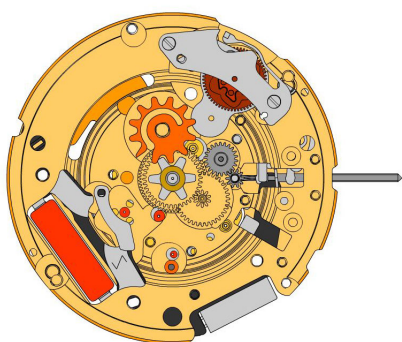



2000.628.G 1.		Platine
2130.204.CO 2.		Couvre-mécanisme Couvre-mécanisme tenue par 43 vis 4000.321.
4000.321 3.		Vis
3017.057 4.		Tirette
3015.074 5.		Bascule (3 positions) Mise en tension du ressort.
3001.042.FI 6.		Pignon coulant
3000.189.CO 7.		Tige de mise à l'heure
2020.166 8.		Pont de bascule Pont de bascule tenue par 1 vis 4000.328.
4000.328 9.		Vis
2130.199 10.		Plaquette de tige Plaquette de tige tenue par 1 vis 4000.312.
4000.312 11.		Vis
3622.042 12.		Stator Marquage [Z] sur le stator.
3715.103.RK 13.		Rotor
3147.056.CO 14.		Roue intermédiaire
3122.059.CO 15.		Roue moyenne
3136.163.CO 16.		Roue de seconde au centre court
3136.167.CO 17.		Roue de petite seconde (Aig.1)

D

E

F

2020.180.G 18.		Pont de rouage Pont de rouage tenue par 3 vis 4000.279.
4000.279 19.		Vis
3601.117.G 20.		Bride pile (+) Bride latérale tenue par 1 vis 4000.244.
4000.244 21.		Vis
3621.060.RK 22.		Bobine Attention: Prendre la bobine uniquement par le noyau de bobine gris.
3603.074 23.		Isolateur bride (-)
3603.075 24.		Isolateur pile
3601.116 25.		Bride - Placer la bride selon image.
3612.181 26.		Module électronique Module électronique tenue par 1 vis 4000.318. Les mesures électroniques peuvent être réaliser maintenant.
4000.318 27.		Schraube
2130.168.G.M01.6004B 28.		Couvre-module électronique Couvre-module électronique tenue par 3 vis 4000.102.
4000.102 29.		Vis
3600.031.HGF 30.		Pile 373

G

H

I



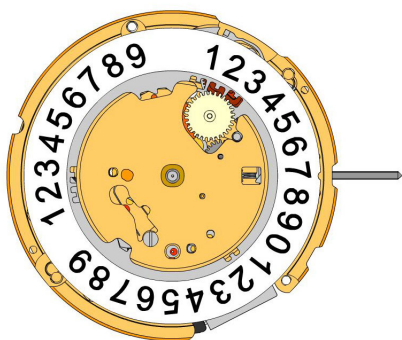

2000.628.G 31.		Platine
3004.232 32.		Roue entraîneuse des dizaines Positionnement de la dent courte de la roue entraîneuse des dizaines en direction le centre du mouvement.
3500.060 33.		Sautoir des dizaines

2130.171 34.		Plaque de maintien du sautoir des dizaines Plaque de maintien du sautoir des dizaines tenue par 2 vis 4000.332.
4000.332 35.		Vis
3004.182.FI 36.		Renvoi
3004.183.FI 37.		Renvoi intermédiaire
3305.307.CO 38.		Chaussee avec entraîneur (Aig.1, borgne)

3007.073.CO 39.		Roue de minuterie
3301.272.CO 40.		Roue des heures (Aig.1)
3315.001 41.		Clinquant
3004.187 42.		Roue entraîneuse de quantième
3500.061 43.		Sautoir de quantième







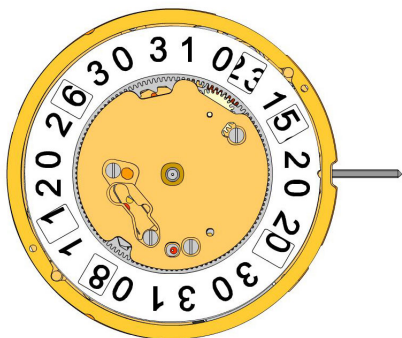



J

3504.217.AF.1.A 44.		Indicateur des unités (standard) Marquage de l'indicateur à 3 heures.
3147.057 45.		Roue intermédiaire dizaines
2130.169 46.		Plaque de maintien de l'indicateur de quantième Plaque de maintien de l'indicateur de quantième tenue par 1 vis 4000.312.
4000.312 47.		Vis
3905.070 48.		Ressort sautoir de quantième Insertion du ressort sautoir de quantième dans l'ouverture.



K

3504.218.AF.1.A 49.		Indicateur des dizaines (standard) Marquage de l'indicateur à 3 heures.
2130.170 50.		Plaque de maintien du mécanisme de quantième Plaque de maintien du mécanisme de quantième tenue par 3 vis 4000.312.
4000.312 51.		Vis
3506.075.G 52.		Support de cadran

8200 53.		Moebius 8200
9014 54.		Moebius 9014
124 55.		Jismaa 124
9020 56.		Moebius 9020

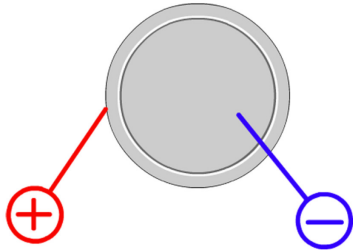

Pile	373
Tension	1.55 V

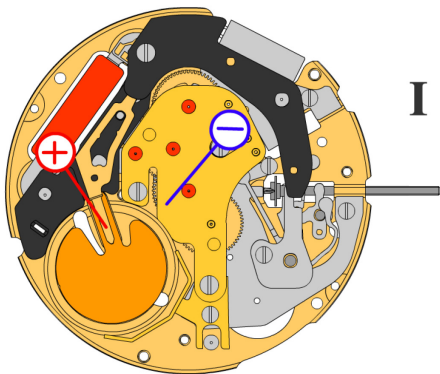

Tige de mise à l'heure en position I, calendrier hors engrenage, intervalle de mesure 60 s pour la marche et la consommation:

Consommation typique	1.03 μA
Consommation maximale	1.85 μA
Marche	-10s/M. .. +20s/M.
Limite inférieure de la tension de fonctionnement	1.20 V

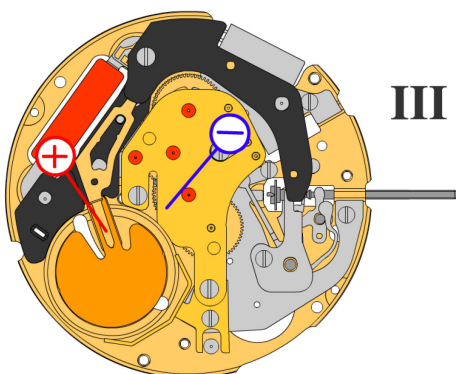

Tige de mise à l'heure en position III, intervalle de mesure 60 s:

Typical consumption	0.10 μA
Maximal consumption	0.30 μA

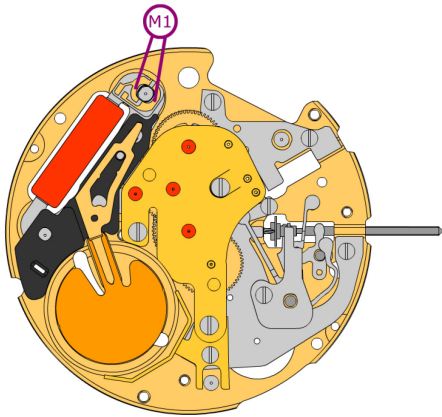

Résistance de la bobine M1

1.61 k Ω .. 1.81 k Ω

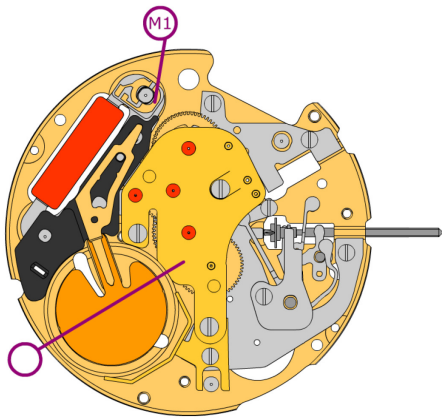

Isolation de la bobine M1

∞ k Ω