

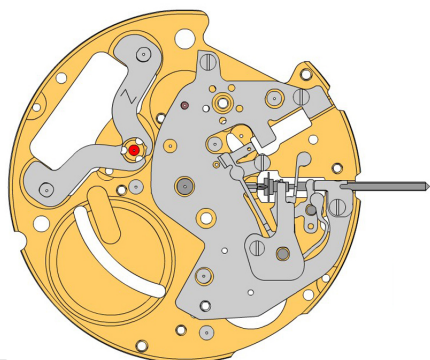

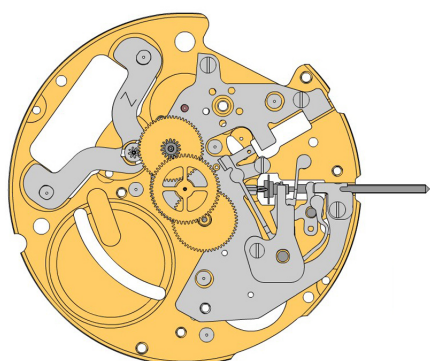

A











B











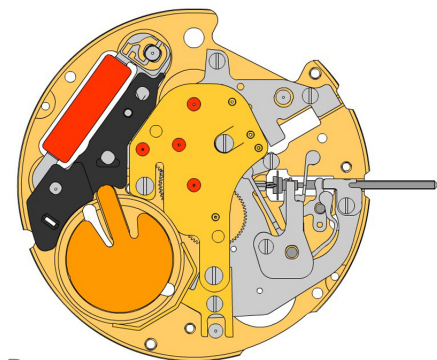
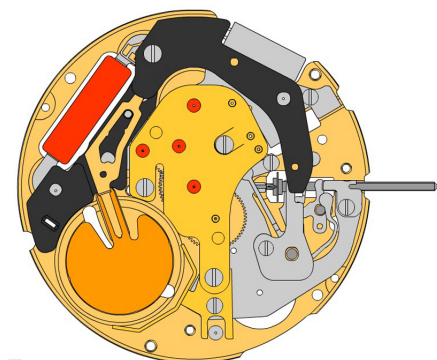
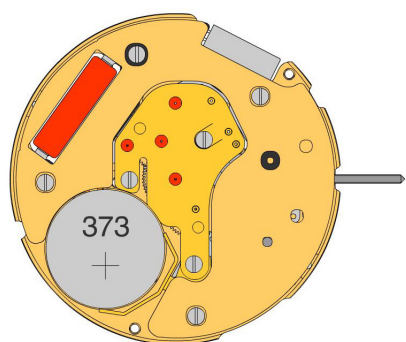





C

2000.628.G 1.		Platine
2130.204.CO 2.		Couvre-mécanisme Couvre-mécanisme tenue par 3 vis 4000.321.
4000.321 3.		Vis

3017.057 4.		Tirette
3015.074 5.		Bascule (3 positions) Mise en tension du ressort.
3001.042.FI 6.		Pignon coulant
3000.189.CO 7.		Tige de mise à l'heure
2020.166 8.		Pont de bascule Pont de bascule tenue par 1 vis 4000.228.
4000.328 9.		Vis
2130.199 10.		Plaquette de tige Plaquette de tige tenue par 1 vis 4000.312.
4000.312 11.		Vis
3622.042 12.		Stator Marquage [Z] sur le stator.

3715.103.RK 13.		Rotor
3147.056.CO 14.		Roue intermédiaire
3122.059.CO 15.		Roue de moyenne
3136.160.CO 16.		Roue de seconde au centre (Aig.1)

D

E

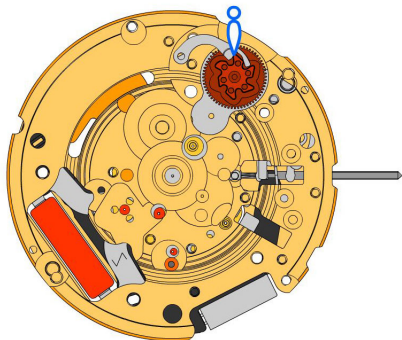
F

2020.180.G 17.		Pont de rouage Pont de rouage tenue par 3 vis 4000.279.
4000.279 18.		Vis
3601.117.G 19.		Bride pile (+) Bride tenue par 1 vis 4000.244.
4000.244 20.		Vis
3621.060.RK 21.		Bobine Attention: Prendre la bobine uniquement par le noyau de bobine gris.
3603.074 22.		Isolateur bride (-)
3603.075 23.		Isolateur pile
3601.116 24.		Bride - Placer la bride selon image.
3612.181 25.		Module électronique Module électronique tenue par 1 vis 4000.318. Les mesures électroniques peuvent être réaliser maintenant.
4000.318 26.		Schraube
2130.168.G.M01.6003B 27.		Couvre-module électronique Couvre-module électronique tenue par 3 vis 4000.102.
4000.102 28.		Vis
3600.031.HGF 29.		Pile 373

G

 2000.628.G
30.

Platine

 3004.232
31.

Roue entraîneuse des dizaines
Positionnement de la dent courte de la roue entraîneuse des dizaines en direction le centre du mouvement.

 3500.060
32.

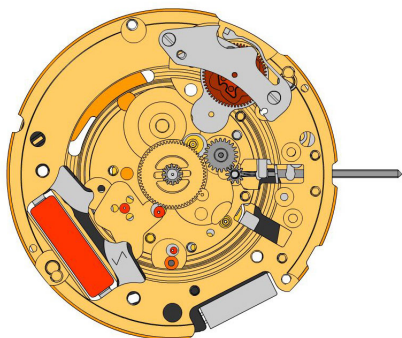
Sautoir des dizaines

H

 2130.171
33.

Plaque de maintien du sautoir des dizaines
Plaque de maintien du sautoir des dizaines tenue par 2 vis 4000.332. Mise en tension du ressort.

 3004.182.FI
34.

Renvoi

 3004.183.FI
35.

Renvoi intermédiaire

 3305.305.CO
36.

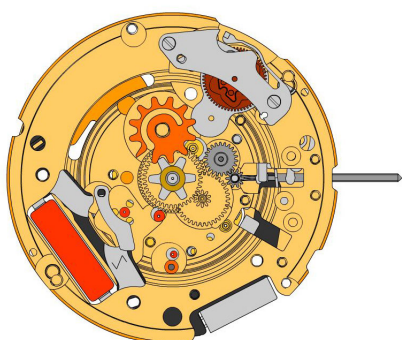
Chaussee avec entraîneur (Aig.1)

I

 3007.073.CO
37.

Roue de minuterie

 3301.271.CO
38.

Roue des heures (Aig.1)

 3315.001
39.

Clinquant

 3004.187
40.



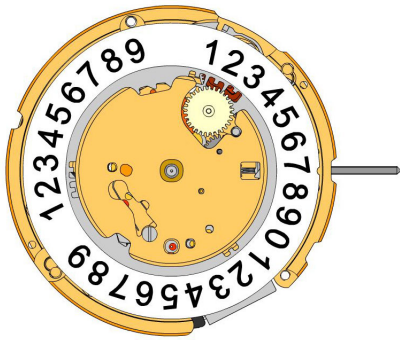

Roue entraîneuse de quantième

 3500.061
41.

Sautoir de quantième







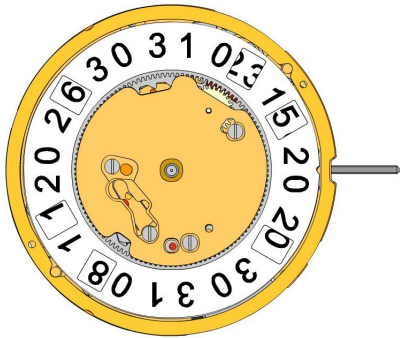



J

3504.217.AF.1.A 42.		Indicateur des unités (standard) Marquage de l'indicateur à 3 heures.
3147.057 43.		Roue intermédiaire dizaines
2130.169 44.		Plaque de maintien de l'indicateur de quantième Plaque de maintien de l'indicateur de quantième tenue par 1 vis 4000.312.
4000.312 45.		Vis
3905.070 46.		Ressort sautoir de quantième Insertion du ressort sautoir de quantième dans l'ouverture.



K

3504.218.AF.1.A 47.		Indicateur des dizaines (standard) Marquage de l'indicateur à 3 heures.
2130.170.G 48.		Plaque de maintien du mécanisme de quantième Plaque de maintien du mécanisme de quantième tenue par 3 vis 4000.312.
4000.312 49.		Vis
3506.075.G 50.		Support de cadran

8200 51.		Moebius 8200
9014 52.		Moebius 9014
124 53.		Jismaa 124
9020 54.		Moebius 9020

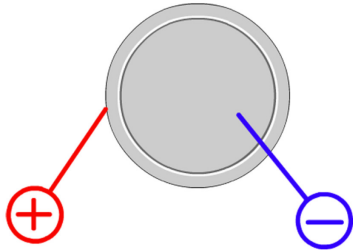

Pile	373
Tension	1.55 V

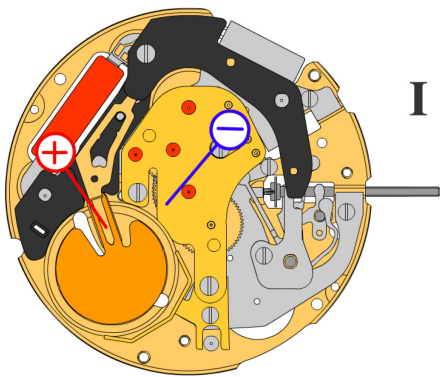
I

Tige de mise à l'heure en position I, calendrier hors engrenage, intervalle de mesure 60 s pour la marche et la consommation:

Consommation typique	1.03 μA
Consommation maximale	1.85 μA
Marche	-10s/M. .. +20s/M.
Limite inférieure de la tension de fonctionnement	1.20 V

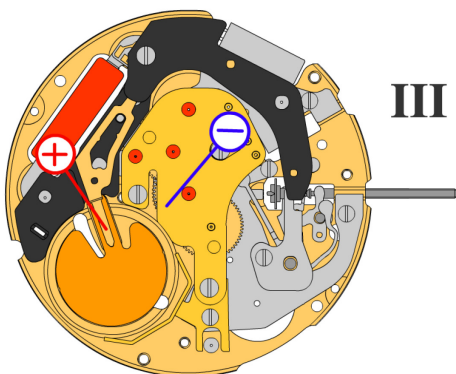
III

Tige de mise à l'heure en position III, intervalle de mesure 60 s:

Typical consumption	0.10 μA
Maximal consumption	0.30 μA

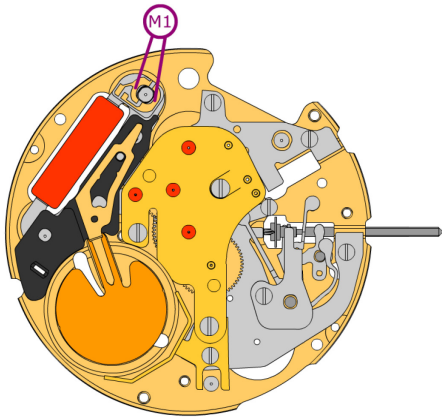

Résistance de la bobine M1

1.61 k Ω .. 1.81 k Ω

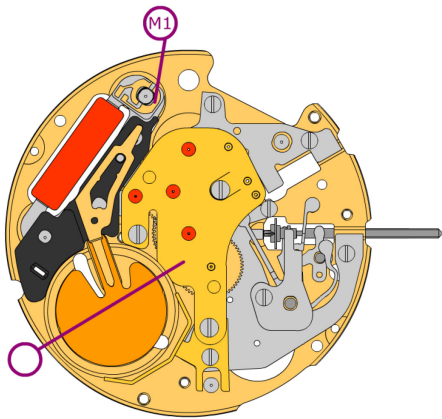

Isolation de la bobine M1

∞ k Ω