

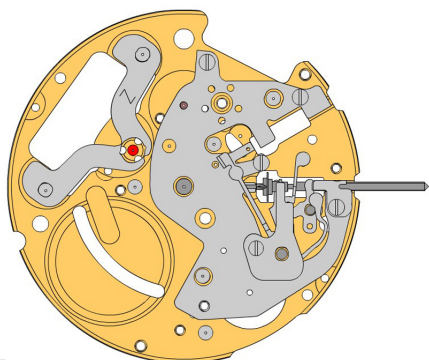

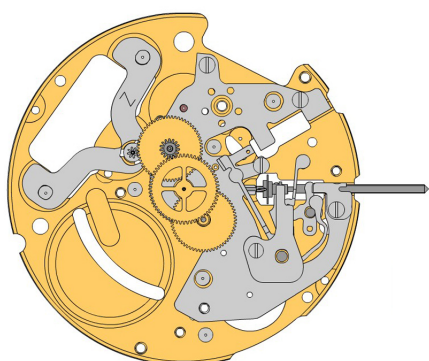

A











B



C

2000.628.G 1.		Werkplatte
2130.204.CO 2.		Deckplatte für Stelleinrichtung Deckplatte für Stelleinrichtung gehalten durch 3 Schrauben 4000.321.
4000.321 3.		Schraube

3017.057 4.		Winkelhebel
3015.074 5.		Wippe (3 Positionen) Den Federarm spannen.
3001.042.FI 6.		Kupplungstrieb
3000.189.CO 7.		Stellwelle
2020.166 8.		Wippenbrücke Wippenbrücke gehalten durch 1 Schraube 4000.328.
4000.328 9.		Schraube
2130.199 10.		Halteplatte für Stellwelle Halteplatte für Stellwelle gehalten durch 1 Schraube 4000.312.
4000.312 11.		Schraube
3622.042 12.		Stator Markierung [Z] auf Stator.

3715.103.RK 13.		Rotor
3147.056.CO 14.		Zwischenrad
3122.059.CO 15.		Kleinbodenrad
3136.160.CO 16.		Zentrumsekundenrad (Aig.1)

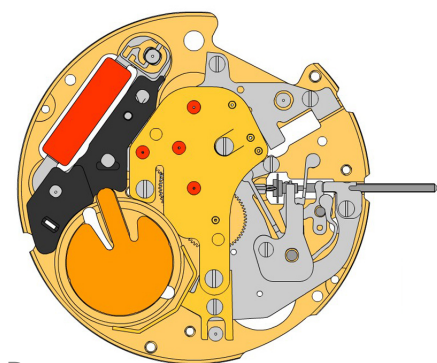



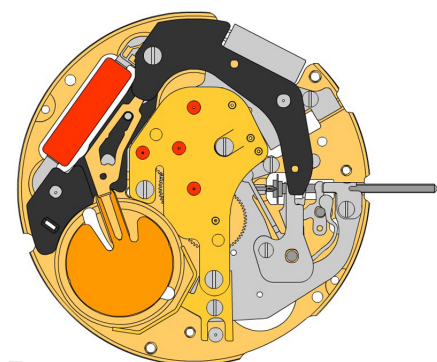



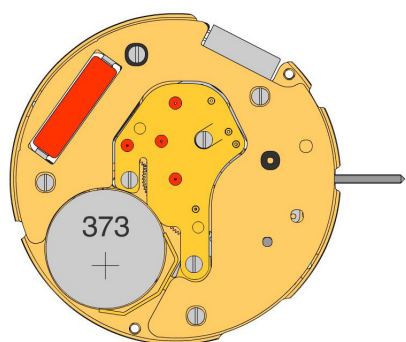





D



E



F

2020.180.G 17.		<b>Räderwerkbrücke</b> Räderwerkbrücke gehalten durch 3 Schrauben 4000.279.
4000.279 18.		<b>Schraube</b>
3601.117.G 19.		<b>Batteriehalter (+)</b> Bügel gehalten durch 1 Schraube 4000.244.
4000.244 20.		<b>Schraube</b>
3621.060.RK 21.		<b>Spule</b> Achtung: Spule nur am grauen Spulenkern halten.
3603.074 22.		<b>Isolation für (-) Bügel</b>
3603.075 23.		<b>Isolation für Batterie</b>
3601.116 24.		<b>Bügel -</b> Bügel wie abgebildet ausrichten.
3612.181 25.		<b>Elektronikmodul</b> Elektronikmodul gehalten durch 1 Schraube 4000.318. Elektronische Messungen können nun vorgenommen werden.
4000.318 26.		<b>Schraube</b>
2130.168.G.M01.6003B 27.		<b>Deckplatte für Elektronikmodul</b> Deckplatte für Elektronikmodul gehalten durch 3 Schrauben 4000.102.
4000.102 28.		<b>Schraube</b>
3600.031.HGF 29.		<b>Batterie 373</b>

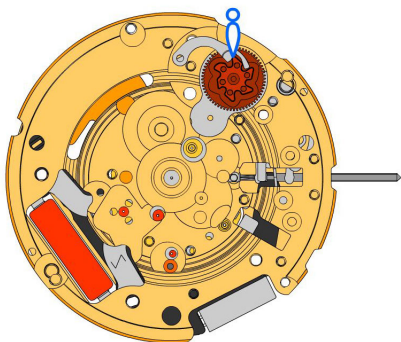

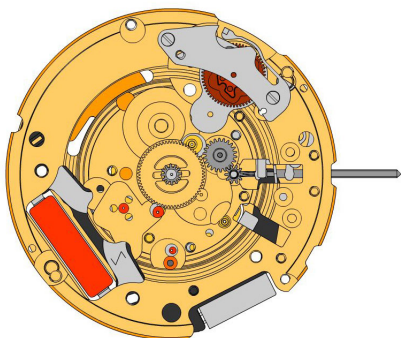

G



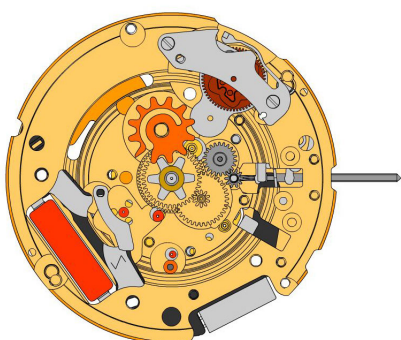









H



I



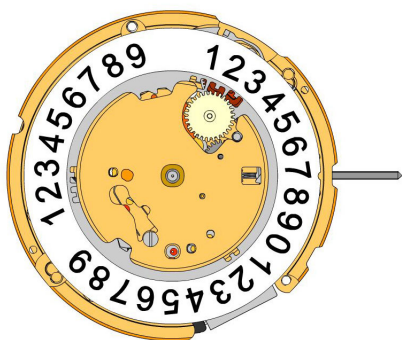

2000.628.G 30.		Werkplatte
3004.232 31.		Zehnermitnehmerrad Kurzen Zahn des Zehnermitnehmerrades in Richtung Werkszentrum positionieren.
3500.060 32.		Zehnerraste

2130.171 33.		Halteplatte für Zehnerraste Halteplatte für Zehnerraste gehalten durch 2 Schrauben 4000.332. Den Federarm spannen.
4000.332 34.		Schraube
3004.182.FI 35.		Zeigerstellrad
3004.183.FI 36.		Zwischenzeigerstellrad
3305.305.CO 37.		Minutenrohr mit Mitnehmer (Aig.1)

3007.073.CO 38.		Wechselrad
3301.271.CO 39.		Stundenrad (Aig.1)
3315.001 40.		Friktionsfeder
3004.187 41.		Datumsanzeiger-Mitnehmerrad
3500.061 42.		Datumraste





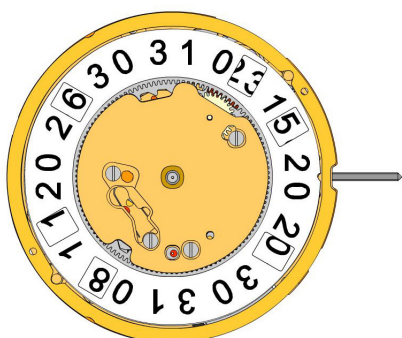

J

3504.217.AF.1.A 43.		Einer Anzeiger (Standard) Einbuchtung im Disc bei 3 Uhr.
3147.057 44.		Zehnerzwischenrad
2130.169 45.		Halteplatte für Datumanzeige Halteplatte für Datumanzeige Mit 1 Schraube 4000.312 festschrauben.
4000.312 46.		Schraube
3905.070 47.		Feder für Datumraste Feder für Datumsraste in die Öffnung einfügen.



K

3504.218.AF.1.A 48.		Zehner Anzeiger (Standard) Einbuchtung im Disc bei 3 Uhr.
2130.170.G 49.		Halteplatte für Datum-Mechanismus Halteplatte für Datum-Mechanismus gehalten durch 3 Schrauben 4000.312.
4000.312 50.		Schraube
3506.075.G 51.		Träger für Zifferblatt

8200 52.		Moebius 8200
9014 53.		Moebius 9014
124 54.		Jismaa 124
9020 55.		Moebius 9020

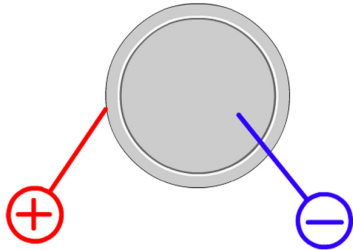

Batterie	<b>373</b>
Spannung	<b>1.55 V</b>

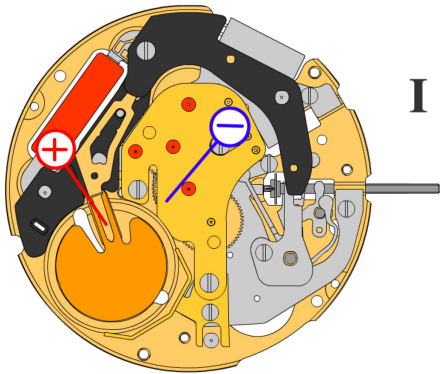
**I**

*Stellwelle in Position I, Kalender nicht im Eingriff,  
60 s Messintervall für Gang und Verbrauch:*

Typischer Verbrauch	<b>1.03 <math>\mu</math>A</b>
Maximaler Verbrauch	<b>1.85 <math>\mu</math>A</b>
Gang	<b>-10s/M. .. +20s/M.</b>
Untere Funktionsspannungsgrenze	<b>1.20 V</b>

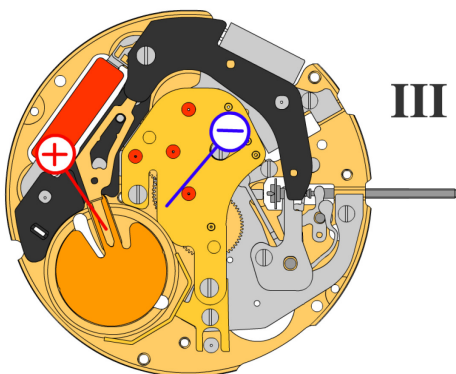
**III**

*Stellwelle in Position III, 60 s Messintervall:*

Typischer Verbrauch	<b>0.10 <math>\mu</math>A</b>
Maximaler Verbrauch	<b>0.30 <math>\mu</math>A</b>

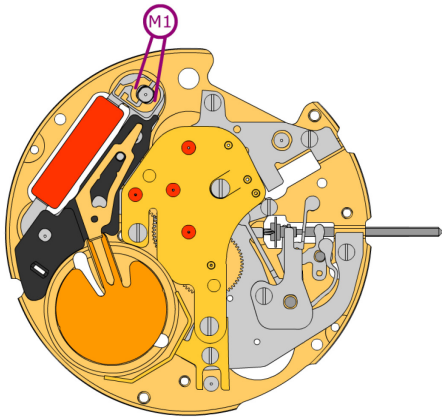

Spulenwiderstand M1

**1.61 k $\Omega$  .. 1.81 k $\Omega$**

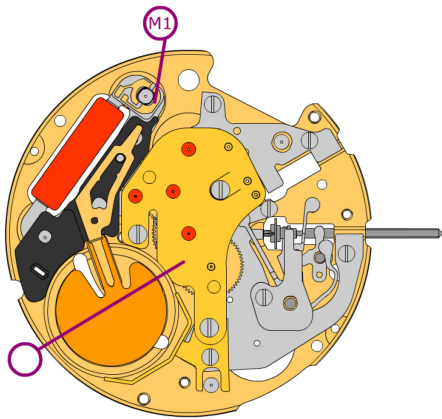

Spulenisolation M1

**$\infty$  k $\Omega$**