

10 1/2<sup>mm</sup>

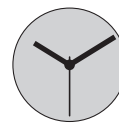

502



503

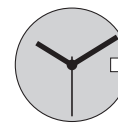

505

### Funktionen

### Fonctions

### Functions

Kaliber	Stellwellenpos.	Funktionen
Calibre	Pos. de tige	Fonctions
Caliber	Stem position	Functions
502, 503	1	Normale Position / Position normale / Running position
	2	Zeiger stellen, Sekunden-Stopp mit Unterbruch der Motorimpulse Mise à l'heure, stop-seconde avec interruption des impulsions moteur Hand setting, stop-second with interruption of motor pulses
505	1	Normale Position / Position normale / Running position
	2	Datumskorrektur / Correction de la date / Date correction
	3	Zeiger stellen, Sekunden-Stopp mit Unterbruch der Motorimpulse Mise à l'heure, stop-seconde avec interruption des impulsions moteur Hand setting, stop-second with interruption of motor pulses

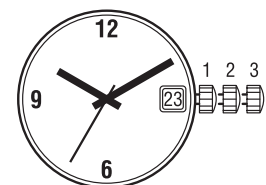

### Batterie

### Pile

### Battery

Kaliber	Batterie	Spannung	Artikelnummer RONDA
Calibre	Pile	Voltage	Numero d'article RONDA
Caliber	Battery	Tension	Part number RONDA
502, 503, 505	371 / SR920SW	1.55 V	3600.015.HGF

10 1/2''' 502, 503, 505

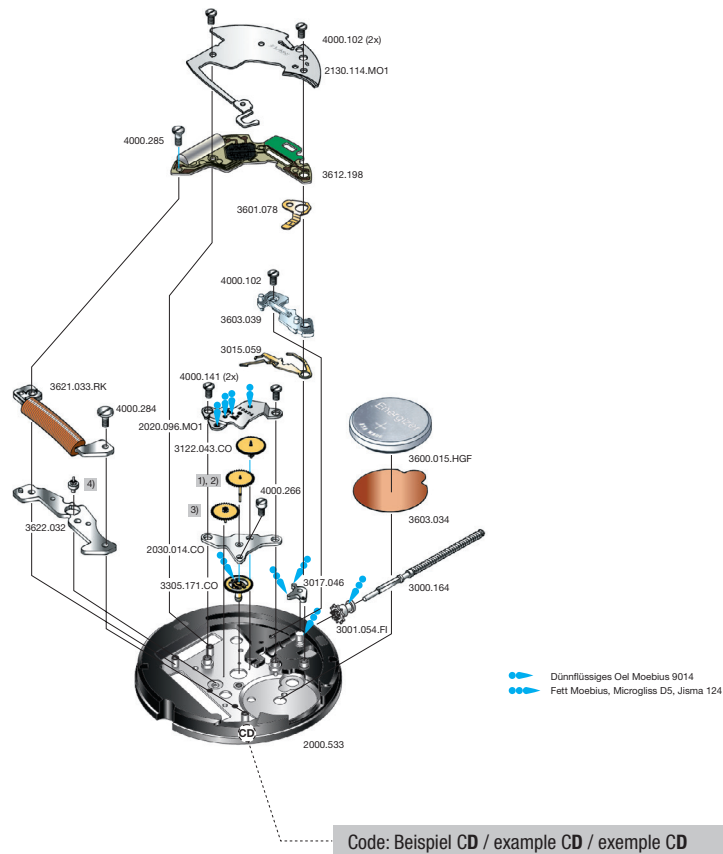

Cal. 503	Werkseite / Côté mouvement / Movement side		
Plan No.	Bestandteile	Fournitures	Spare Parts
2000.533	Werkplatte	Platine	Main plate
2020.096.MO1	Räderwerkbrücke	Pont rouge	Train w. bridge
2030.014.CO	Zentrumbrücke	Pont centre	Centre bridge
2130.114.MO1	Modul-Abdeckp.	Couvre module	Module cover pl.
3000.164	Stellwelle	Tige	Stem
3001.054.FI	Kupplungstrieb	Pignon coulant	Sliding pinion
3015.059	Kuppl.-triebhebel	Bascule	Yoke
3017.046	Winkelhebel	Tirette	Setting lever
3122.043.CO	Kleinbodenrad	Roue moyenne	Third wheel
1)	Sekundenrad	Roue secondes	Second-wheel
3)	Zwischenrad	Roue interméd.	Intermed. wheel
3305.171.CO	Minutenrohr	Chaussée	Cannon pinion
3600.015.HGF	Batterie	Pile	Battery
3601.078	Batterie-Kontakt	Bride contact	Battery contact
3603.034	Batterie-Isolation	Isolateur pile	Battery insulation
3603.039	Deckplatte/ Ste.	Couvre mécan.	Setting lev. cover
3612.198	Modul	Module	Module
3621.033.RK	Spule	Bobine	Coil
3622.032	Stator	Stator	Stator
4)	Rotor	Rotor	Rotor
4000.102	Schraube	Vis	Screw
4000.141	Schraube	Vis	Screw
4000.266	Schraube	Vis	Screw
4000.284	Schraube	Vis	Screw
4000.285	Schraube	Vis	Screw

Abweichungen / Divergences / Deviations

Cal. 505	Werkseite / Côté mouvement / Movement side		
Plan No.	Bestandteile	Fournitures	Spare Parts
3015.060	Kuppl.-triebhebel	Bascule	Yoke

Cal. 502	Werkseite / Côté mouvement / Movement side		
Plan No.	Bestandteile	Fournitures	Spare Parts
2030.012.CO	Zentrumbrücke	Pont centre	Centre bridge
2)	Sekundenrad	Roue secondes	Second-wheel
3)	Zwischenrad	Roue interméd.	Intermed. wheel
3305.210.CO	Minutenrohr	Chaussée	Cannon pinion
4)	Rotor	Rotor	Rotor

Cal. 503, 505		
	Bis Dezember 2015 Jusqu' en Decembre 2015 Untill December 2015	Ab Januar 2016 A partir de Janvier 2016 From January 2016
Code	2. Buchstabe ... <b>D</b> Second letter ... <b>D</b> 2 <sup>ème</sup> chiffre: ... <b>D</b>	2. Buchstabe: ab <b>E</b> Second letter: from <b>E</b> 2 <sup>ème</sup> chiffre: à partir de <b>E</b>
1)	3136.090.CO	3136.194.CO
3)	3147.019.CO	3147.092.CO
4)	3715.089.RK	3715.144.RK

Die obigen 3 Teile bilden jeweils eine Gruppe. Deshalb sind die 3 Teile jeder Gruppe nicht einzeln gegeneinander austauschbar.

Les 3 fournitures ci-dessous forment un groupe individuel. C'est pourquoi les 3 fournitures de chaque groupe ne sont pas interchangeables.

The 3 parts mentioned above are forming an individual group. Therefore the 3 parts of each group are not interchangeable.

Cal. 502		
	Bis Dezember 2015 Jusqu' en Decembre 2015 Untill December 2015	Ab Januar 2016 A partir de Janvier 2016 From January 2016
Code	2. Buchstabe ... <b>D</b> Second letter ... <b>D</b> 2 <sup>ème</sup> chiffre: ... <b>D</b>	2. Buchstabe: ab <b>E</b> Second letter: from <b>E</b> 2 <sup>ème</sup> chiffre: à partir de <b>E</b>
2)	3136.093.CO	3136.196.CO
3)	3147.019.CO	3147.092.CO
4)	3715.089.RK	3715.144.RK

Die obigen 3 Teile bilden jeweils eine Gruppe. Deshalb sind die 3 Teile jeder Gruppe nicht einzeln gegeneinander austauschbar.

Les 3 fournitures ci-dessous forment un groupe individuel. C'est pourquoi les 3 fournitures de chaque groupe ne sont pas interchangeables.

The 3 parts mentioned above are forming an individual group. Therefore the 3 parts of each group are not interchangeable.

# Werkaufbau

# Assemblage

# Assembling

10 1/2''' 505

10 1/2''' 502, 503

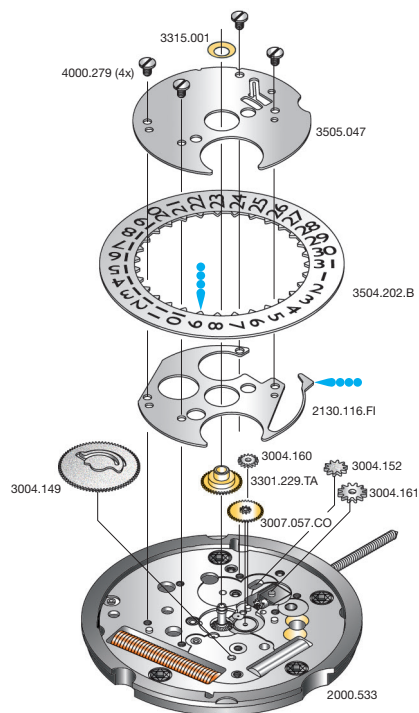

●●●●● Fett Moebius, Microgliss 1 4

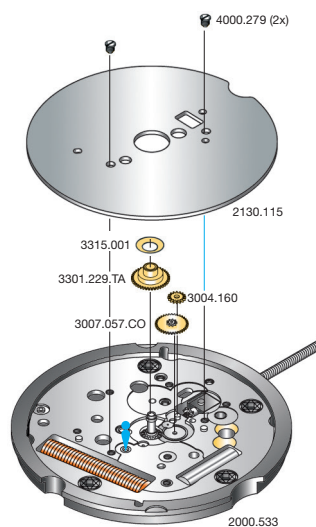

● Düninflüssiges Oel Moebius 9014

Cal. 505	Zifferblattseite / Côté cadran / Dial side		
Plan No.	Bestandteile	Fournitures	Spare Parts
2130.116.FI	Kalenderplatte	Plaque calendrier	Date ind. plate
3004.149	Datummitn.-rad	Renvoi entraîin.	Ind. driving wheel
3004.152	Umkehrad	Baladeur	Sliding gear
3004.160	Zeigerstellrad	Renvoi minuterie	Setting wheel
3004.161	Verbindungsrad-Kupplungtrieb	Renvoi pig. coulant	Sliding pinon setting wheel
3007.057.CO	Wechselrad	Minuterie	Minute wheel
3301.229.TA	Stundenrad	Canon	Hour wheel
3315.001	Spreizfeder	Clinquant	Washer
3504.202.B	Datumanzeiger	Bague	Date indicator
3505.047	Kal.-Abdeckplatte	Couvercle calend.	Date ind. cover
4000.279	Schraube	Vis	Screw

Cal. 502, 503	Zifferblattseite / Côté cadran / Dial side		
Plan No.	Bestandteile	Fournitures	Spare Parts
2130.115	Zeigerwerkplatte	Plaque maintien	Maintening plate
3004.160	Zeigerstellrad	Renvoi minuterie	Setting wheel
3007.057.CO	Wechselrad	Minuterie	Minute wheel
3301.229.TA	Stundenrad	Canon	Hour wheel
3315.001	Spreizfeder	Clinquant	Washer
4000.279	Schraube	Vis	Screw

# Elektr. Messungen

# Contrôles électriques

# Electrical checking

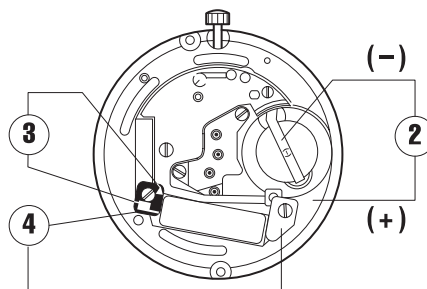
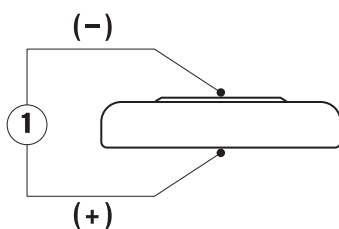

Kaliber Calibre Caliber	Pos. Pos. Pos.	Einheit Unité Unit	Messwerte Valeurs mesurées Measured values	Kontrolle Contrôle Check	Bemerkungen Remarques Remarks
502, 503, 505	1	V	1,55	Batterie-Spannung Tension de la pile Battery voltage	Batterie herausnehmen und messen Enlever et mesurer la pile Remove battery for measuring
502, 503, 505	2	µA	1,10–1,85 2,20–2,65	Stromaufnahme Consom. de courant Power consumption	Ohne Batterie, mit externer Speisung Sans pile, avec alimentation externe Without battery, with external power supply
502, 503, 505	2	V	≤ 1,30	Funktionskontrolle bei Minimalspannung Contrôle de fonctionnement à tension minimale Check with lowest possible voltage	Ohne Batterie, mit externer Speisung Sans pile, avec alimentation externe Without battery, with external power supply
502, 503, 505	3	KΩ	1,90–2,10 2,35–2,55	Spulenwiderstand Résistance de la bobine Resistance of the coil	Ohne Batterie Sans pile Without battery
502, 503, 505	4	KΩ	∞	Spulenisolation Isolation de la bobine Coil insulation	Ohne Batterie Sans pile Without battery
502, 503, 505		Sek./Monat sec./mois sec./month	- 10/+ 20	Induktivsonde 60 Sek. Senseur inductif 60 sec. Inductive sensor 60 sec.	Mit Batterie Avec pile With battery

## Einschalen / Werkzeuge

## Emboîtage / outils

## Casing / tools

Nr. H 50x.1A



Nr. H 50x.1T



SWISS MADE & SWISS PARTS	
Schraube Vis Screw	

### Zeigersetzen

Maximale Aufpresskraft:

- Stunden und Minutenzeiger: max. 40N
- Sekundenzeiger: max. 30N

Beim Zeigersetzen muss das Werk abgestützt werden.

### Poser les aiguilles

Force de chassage maximale:

- Aiguilles des heure et des minutes: max. 40N
- Aiguille des secondes: max. 30N

Lors de la pose d'aiguilles, le mouvement doit être soutenu.

### Hand setting

Maximal force:

- Hour and minute hands: max. 40N
- Second hand: max. 30N

The movement needs to be supported for hand setting.

<b>Kal. 502, 503 Stellwelle entfernen</b> Beim Entfernen der Stellwelle muss sich die Stellwelle in <b>Position 1</b> (gedrückt) befinden, bevor auf den Winkelhebel gedrückt wird.	<b>Kal. 505 Stellwelle entfernen</b> Beim Entfernen der Stellwelle muss sich die Stellwelle in <b>Position 2</b> befinden, bevor auf den Winkelhebel gedrückt wird.
<b>Kal. 502, 503 Enlever la tige</b> En enlevant la tige, la tige doit se trouver en <b>position 1</b> (poussée), avant de pousser sur la tirette.	<b>Kal. 505 Enlever la tige</b> En enlevant la tige, la tige doit se trouver en <b>position 2</b> , avant de pousser sur la tirette.
<b>Kal. 502, 503 Stem removal</b> For removal of the stem, the stem must be in <b>position 1</b> (pressed in) prior to apply pressure to the setting lever.	<b>Kal. 505 Stem removal</b> For removal of the stem, the stem must be in <b>position 2</b> prior to apply pressure to the setting lever.